

# AFX 8010 AXIAL-FLOW® COMBINES

## PRODUCT SUPPORT KITS

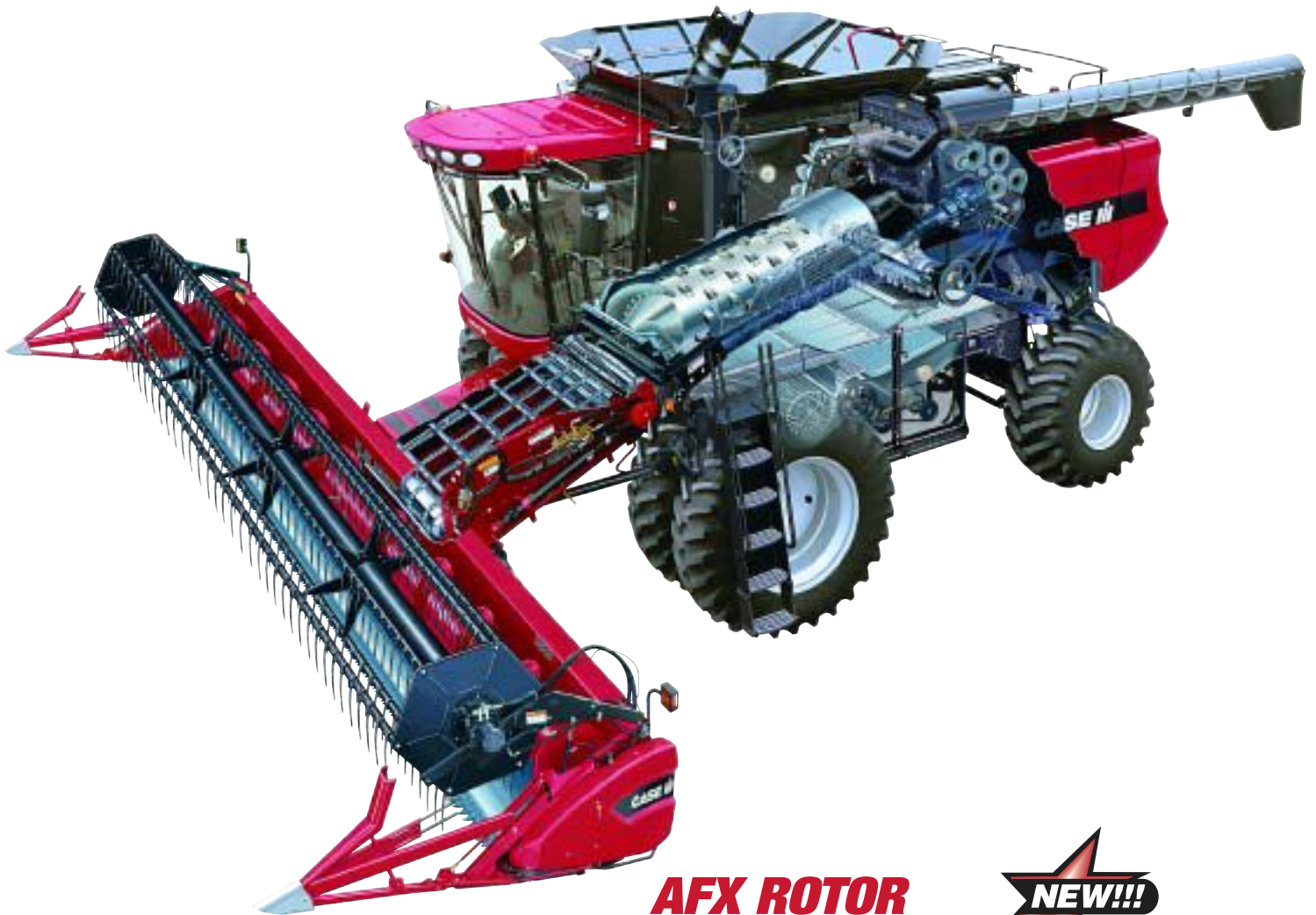

**AFX ROTOR**

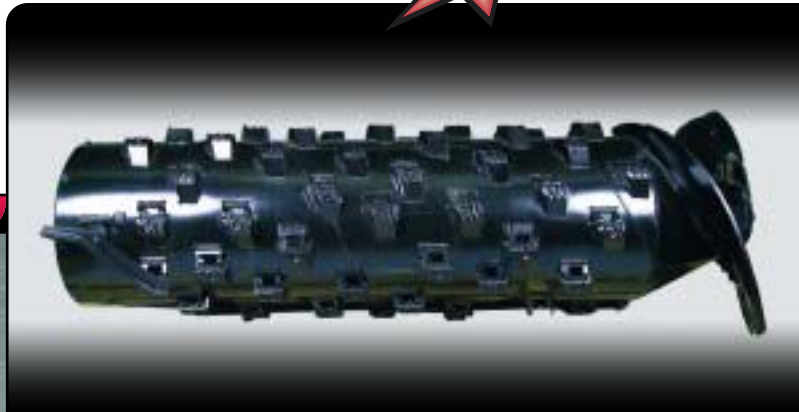

**CASE IH**

# TABLE OF CONTENTS

Description	Page
Accessories/Toys .....	27
Advanced Farming System .....	30
AFS Universal Receiver Kit .....	30
AFX 8010 Scale Model Toys .....	27
AFX Rotor .....	19
Auger Bearing Kit .....	7
Auger Finger Shaft Bearing Kit .....	11
Axle and Operator Deck Extensions .....	32
Battery Power Grease Gun .....	27
Bearing Kit-Feeder Drum Drive/Rock Trap Drive .....	16
Bearing Kit-Feeder Idler Drum .....	16
Bubble Up Auger Bearing Kit .....	22
Bulk Tines .....	10
Case IH "Xtra-Vision" Vehicle Observation System .....	30
Chain Breaker .....	27
Clean Grain Bearing Kits .....	22
Clean Grain Elevator and Grain Tank Cross Auger Slow Down Kit .....	24
Cleaning Fan Bottom Shield Kit .....	24
Cleaning System Kits .....	22
Combine Lighting Kits .....	18
Corn Head Row Unit .....	14
Corn Head Kits .....	12, 13, 14
Corn Head Knives .....	12
Crop Deflector Kit .....	16
Crop Divider End Assembly .....	9
Crop Dividers and Accessories .....	9, 10
Cross Flow Fan Bearing Kit .....	22
Cutter Bar Rebuild Kits .....	8
Cutting Parts .....	7
Deluxe Hard-to-Thresh Kit .....	25
Deluxe Service Lighting Kit .....	18
Divider Kits .....	15
Drive Shaft Bearing Kit .....	7

**Description****Page**

Drive Sprocket Kit.....	12
Ear Saver Kit.....	12
Ear Saver Kit/Tall Corn.....	14
Extenda-Wear Chains Kit.....	13
Extenda-Wear Rotor Cage.....	21
Feeder Chain Roller Kit.....	16
Feeder Kits.....	16, 17, 32
Feeder Lateral Tilt.....	17
Feeder Rock Trap Kit.....	17
Filters.....	29
Fire Extinguisher Kit.....	27
Fixed Chopper Knife Assembly.....	26
Front Rotor Module Recommendations.....	21
Grain Handling Kit/Cleaning System.....	24, 25
Grain Handling Kits.....	22, 32
Grain Platform Kits.....	6, 7, 8, 9, 10, 11
Guard Kits.....	8
Guards.....	6
Hard-to-Thresh Cross Auger Trough Kit.....	25
Header Auger Fingers and Kits.....	11
Header Sweep Kit.....	10
Heavy-Duty #557 Chain w/Chrome Pin.....	16
HID Light Kit.....	18
Idler Sprocket Kit.....	12
Impeller Wear Bar Kit.....	19
Knife Drive Assembly.....	11
Ladder Extension Kit.....	27
Light Kit.....	18
Lighting Kits.....	32
Low Profile Divider Point Kits.....	12, 14
Lower Shoe Shaker Arm Bushing Kit.....	22
Lower Shoe Shaker Arm Deluxe Kit.....	22
Moisture Testers.....	28

# TABLE OF CONTENTS (CONTINUED)

Description	Page
Perforated Feeder Floor .....	17
Performance Kits .....	32
Poly Hoods .....	15
Poly-Skid Shoe Kit (for 2020 Flex Series Headers) .....	10
Precision Farming Kits .....	32
Pre-Harvest Planning .....	5
Productivity Tips/Guides .....	31
Rasp Bar and Kits .....	20
Rasp Bar Bolt Kit .....	19
Reel Kits .....	8
Residue Handling Kits .....	32
Residue Management Kits .....	26
Rock Trap Sump Cover Kit .....	17
Rotary Air Screen Brush Kit .....	23
Rotary Air Screen Clip Kit .....	23
Rotary Air Screen Kits .....	23
Rotary Air Screen Wear Strip Kit .....	23
Rotating Straw Chopper Knife Kit .....	26
Rotor Impeller Kit .....	19
Sections .....	7
Self Directed Learning Program .....	31
Separator Adjustment Slide Rule .....	31
Sieves .....	25
Stainless Steel Cage Repair Kits .....	21
Stainless Steel Transport Vane Kit .....	21
Stalk Roll Repair Kits .....	13
Three Beacon Light Kit .....	18
Tine Service Kits .....	10
Unloading Auger Extension, 3' .....	24
Upper Shaker Shoe Bushing Deluxe Kit .....	22
Upper Shaker Shoe Bushing Kit .....	22
Weed Knife Kits .....	12

## **PRE-HARVEST PLANNING**

Case IH has developed combine product support kits designed to enhance the performance of your AFX 8010 Axial-Flow combine. And now is the perfect time to get started on evaluating your maintenance needs before the busy harvest season. Several different viewpoints were factored into the development and design of these performance and maintenance kits including:

- Input from customers like you who own and operate Case IH Axial-Flow combines.
- Advice from Case IH dealers' product support departments. These parts and service specialists have submitted suggestions based on actual experiences in the dealership.
- Data from Case IH combine engineers who work to make improvements on later models, through packaged kits that can be installed on a previous model combine, corn head or grain header.

**Performance Kits:** These kits, such as Crop Dividers and Feeder Rock trap kits, were developed to improve the performance and productivity of your AFX 8010 Combine.

**Maintenance Kits:**  
Examples include corn head repair kits, cutter bar kits and rasp bar kits, designed to make a complete repair on a machine. They include key components and hardware, helping to reduce repeated trips to the dealership for additional pieces needed to complete the repair.

**Service Packs:** These handy carded packs for your shop or toolbox are designed for smaller repairs. Examples include auger fingers and chopper knife kits. These smaller kits still include key parts and attached hardware.

**Complete assembly:** Knife drive boxes or complete rotors have the latest components and are complete and ready to install. These kits can reduce downtime during the season while upgrading your combine with the latest improvements.

While you can install these kits yourself, other kits are best installed by your Case IH dealer who has the training and special tools to install these kits in you Axial-Flow combine. Ask your Case IH dealer for an installed price on any of these kits.

Your recommendations on new kits for your Axial-Flow combines and header are always welcome. Talk to us and we'll submit your ideas to Case IH parts marketing.

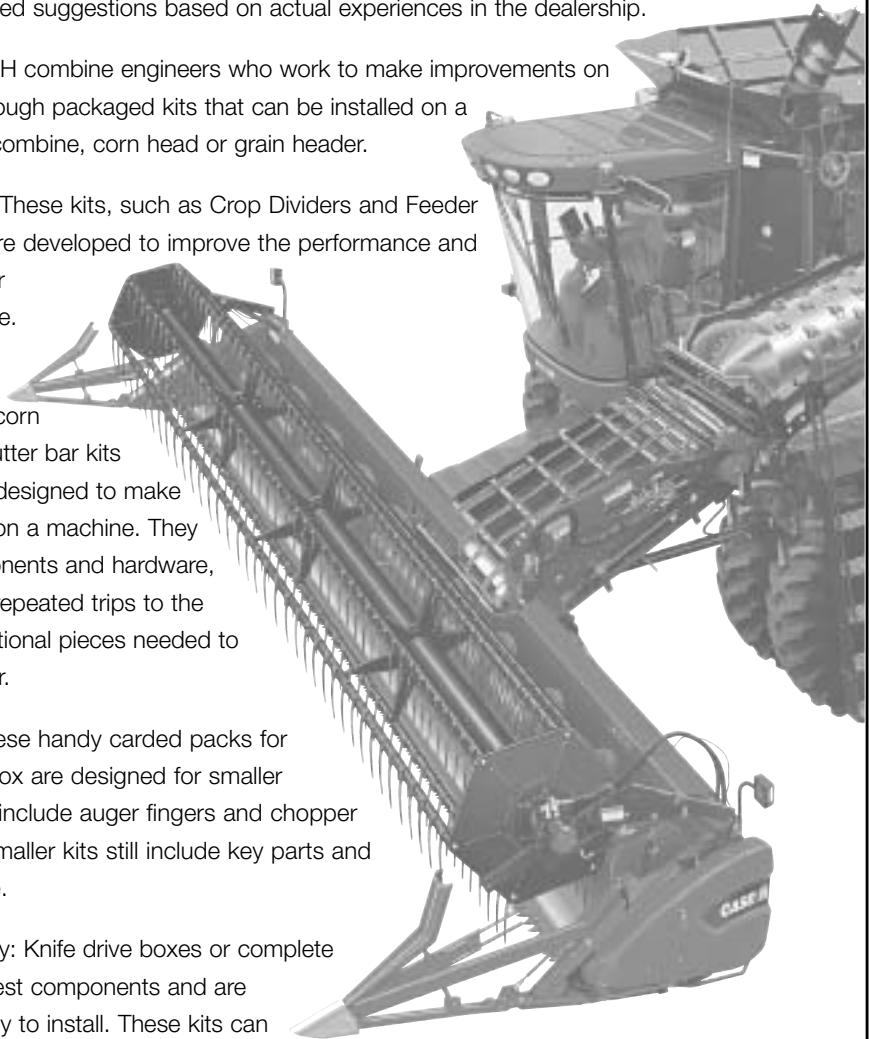

# GRAIN PLATFORM KITS

## GUARDS

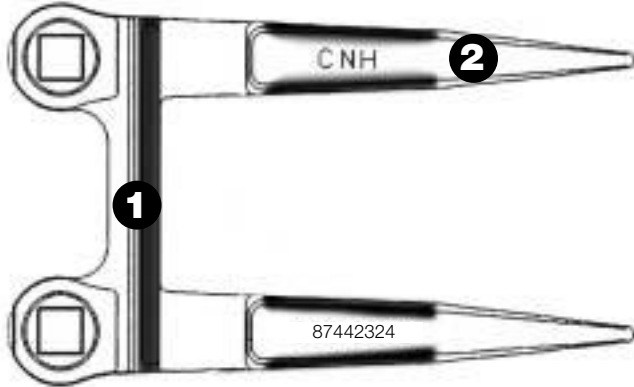

The performance and durability are in the superior double heat treating of critical wear surfaces.

- 1** Case IH employs the high industry standards of using a special heat-treatment process on the back bar to reduce wear between the guard and the section.
- 2** Case IH applies an additional induction-hardening process to the ledger areas to provide longer wear-sharp surface for more efficient cutting. These ledger areas are also wider for additional service life.

Today's machines have increased cutting demands. Made for durability and longer service life, Case IH guards provide top performance in all harvest conditions.



## HEAVY-DUTY HEAT TREATED GUARDS

### Grain Header Guards

PART NO.	DESCRIPTION
87442329	End Guard - 3" System
87045432	Triple Guard - 3" System
87442324	Main Guard - 3" System
87015708	Main Guard - 1 1/2" System
87015706	End Guard - 1 1/2" System
9826150	Main Hold Down Clip - 1 1/2" System

# GRAIN PLATFORM KITS

## GENUINE CASE IH CUTTING PARTS

### Matched Engineered Components For Superior Performance



#### Back Hardened Sections

The back edge of most Case IH sections are hardened to the same Rockwell hardness as the mating surface of the Case IH guard or wear plate to provide:

- Superior durability
- Assures an even wear rate between the two mating surfaces and eliminates the need for frequent adjustments
- Increase section longevity at mating surfaces



- Case IH sections are made from a high carbon steel with induction hardened cutting edge for superior wear line.
- The center of the Case IH section is very ductile for improved toughness.
- Top serrated sections are self-sharpening for a cleaner-smoother cut.
- The back edge of most Case IH sections are hardened for superior durability.

#### KNIVES

PART NO.	DESCRIPTION	APPLICATION
86900832	LH 20 FT	2020
86900833	RH 20 FT	2020
86900834	LH 25 FT	2020
86900835	RH 25 FT	2020
86900834	LH 25 FT	2010
86900835	RH 25 FT	2010
86977981	LH 30 FT	2020
86977982	RH 30 FT	2020
86977981	LH 30 FT	2010
86977982	RH 30 FT	2010

#### SECTION AND KNIFE SELECTION

PART NO.	DESCRIPTION	APPLICATION
86616529	3" END - RH FINE 14 SER/INCH	2010
86616528	3" END - LH FINE 14 SER/INCH	2010
86616527	3" MAIN - FINE 14 SER/INCH	2010
86616693	3" END - RH COARSE 10 SER/INCH	2020
86616692	3" END - LH COARSE 10 SER/INCH	2020
86616689	3" MAIN - COARSE 10 SER/INCH	2020



#### Drive Shaft Bearing Kit

- Handy Service Pack
- Kit Includes Bearing, Flange, & Mounting Hardware
- Application 2010 & 2020 Headers

Part no. 87297938



#### Auger Bearing Kit - Drive End

- Handy Service Pack
- Kit Includes Bearing, Collar, Flanges & Mounting Hardware
- Application 2010 & 2020 Headers

Part no. 87297943

**Very important:** Every component in the cutting system is designed and tested by Case IH engineering and manufactured only by approved suppliers.



# GRAIN PLATFORM KITS

## GUARD KITS – 2 & 4 PACK

- Kits include guards, hold down clips, shims and hardware
- Handy service 4-pack to repair two-foot sections or 2-pack to repair one-foot sections
- Kits for 3" systems
- Kits with double heat-treated guard for longer wear-life and improved toughness

### GUARD KITS – 2-PACK - 3" SYSTEM DOUBLE HEAT TREATED GUARD

PART NO.	DESCRIPTION
87298212	KIT WITH ADJUSTABLE HOLD DOWN CLIP
87297170C	ADJUSTABLE HOLD DOWN CLIP

### GUARD KITS – 4-PACK - 3" SYSTEM DOUBLE HEAT TREATED GUARD

PART NO.	DESCRIPTION
87298213	KIT WITH ADJUSTABLE HOLD DOWN CLIP

## KITS FOR NEWER STYLE HEADER REELS

### Reel Repair Kit

Gather more grain when your 2000 series pick-up reel is in top shape and ready for tough harvest conditions. New reel repair kits offer:

- Convenience – key components and hardware in one kit
- Save – time and money
- Confidence – your reel will feed your valuable crop to your combine



Reel Arm Bearing Kit  
Part No. B95624



Reel Arm Bushing Kit  
Part No. B95644 - One Side  
Part No. B95645 - Two Sides



Reel Arm Bearing Kit  
Part No. B95623 - Kit for one spider

## CUTTER BAR REBUILD KITS

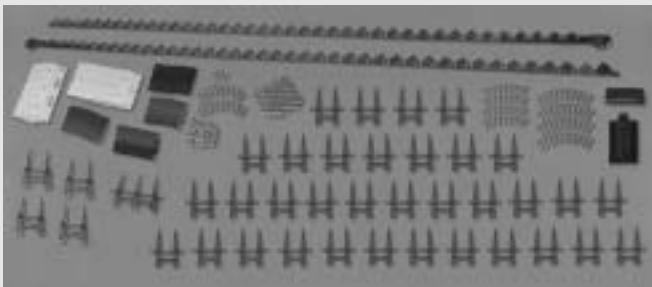

3" System

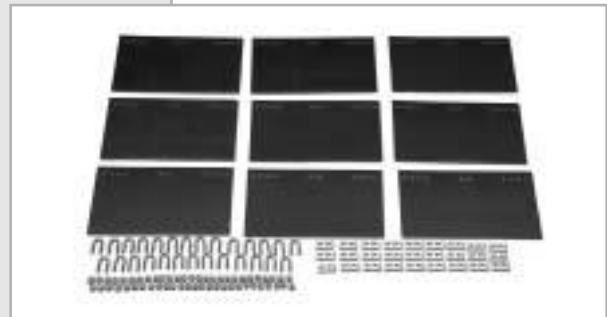

### For 2010 and 2020 Headers

Kits available with or without knives. Kits are complete and include: guards, hold-down clips, wear plates and hardware. Kit may or may not include the knife depending on ordering option.

Restore your grain header to "like-new" performance with a complete cutter bar rebuild kit.

#### 3" CUTTER BAR KITS

HEADER SIZE	DRIVE	TYPE OF HOLD DOWN CLIP	MODEL	KIT W/O KNIFE	KIT W/ KNIFE
20' FLEX	DOUBLE	ADJUSTABLE	2020	87297974	87297979
25' FLEX	DOUBLE	ADJUSTABLE	2020	87297975	87297980
30' FLEX	DOUBLE	ADJUSTABLE	2020	87297976	87297981
20' RIGID	SINGLE	ADJUSTABLE	2010	87297972	87297973
25' RIGID	DOUBLE	ADJUSTABLE	2010	87297977	87297982
30' RIGID	DOUBLE	ADJUSTABLE	2010	87297978	87297983

### Reel Tine Flap Kit

- Improves crop flow in light crops
- Kit includes nine (9) flaps and mounting hardware

Part No. 86705199

# GRAIN PLATFORM KITS

## GRAIN HEADER KITS

### CROP DIVIDERS

Listed below are divider options for 2010 and 2020 headers.

All kits except the crop divider end assemblies include components for both LH & RH dividers.

#### Crop Divider - Short

- For 2010 and 2020 Headers
- Recommended for short to medium standing crops

Part No. 801462



#### Crop Divider - Medium

- For 2010 and 2020 Headers
- Recommended for medium to tall standing crops

Part No. 87016131



#### Crop Divider End Assembly

- Replacement End for Long Dividers
- Fully assembled-ready to install

Part No. 87298163 (LH)

Part No. 87298164 (RH)



#### Crop Divider - Long

- For 2010 and 2020 Headers
- Recommended for taller tangled crops

Part No. 87016132



# GRAIN PLATFORM KITS

## HEADER KITS

### Crop Dividers and Accessories

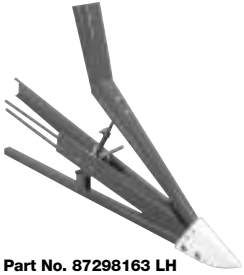

- Complete replacement divider
- Assembled
- 2000 Series with long divider

Part No. 87298163 - (LH)  
Part No. 87298164 - (RH)

Part No. 87298163 LH

### TIME SAVER!



#### Poly Point Kit

Part No. B95408

#### Tube Kit

Part No. B95409



Part No. B95856

### Tine Service Kits

- Handy service kit
- Includes tine and mounting hardware

PART NO.	APPLICATION	SINGLE PIECE NO.
B95856	FULL TINE - MLII REELS HEADER 2001 AND LATER	86608231

### Bulk Tines

PART NO.	APPLICATION
B95872	MLII REELS, 2001 & LATER

### Bulk Tines - 25 pack

PART NO.	APPLICATION
B95857	MLII REELS, 2001 AND LATER



Twenty-five Pack



Large Bulk Pack

## POLY-SKID SHOE KITS FOR 2020 FLEX SERIES HEADERS

Poly-skid shoes improve header performance in wet, sticky soils and extends the life of the metal shoe in sandy, abrasive soils. Kit includes main shoe, end shoes and hardware.



HEADER SIZE	PART NUMBER
20'	87297944
25'	87297945
30'	87297946

### Header Sweep Kit

- Improved feeding
- Kit includes sweep plates and mounting hardware

Part No. 87016167

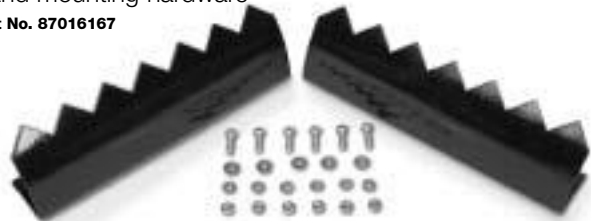

# GRAIN PLATFORM KITS

## HEADER AUGER FINGERS AND KITS

The new Auger Finger is tougher, stronger, more wear resistant, and now has a roll pin installed to capture the Auger Finger safely in the auger tube.

- **SURFACE HARDNESS** - The surface hardness is increased to provide more wear life.
- **CORE HARDNESS** - The core hardness is increased for improved toughness to better resist breaking or bending.
- **ROLL PIN RETAINER** - A roll-pin is positioned between the finger guide and breakpoint to capture any broken finger inside the auger tube. Any broken finger can easily be removed at the operator's convenience.

### STEEL VS. POLY/FIBERGLASS FINGER

Steel is harder than Poly/Fiberglass and will provide substantially more wear life. Stronger - tougher - harder - longer lasting and with the retainer system the new Case IH steel auger finger is the better choice.

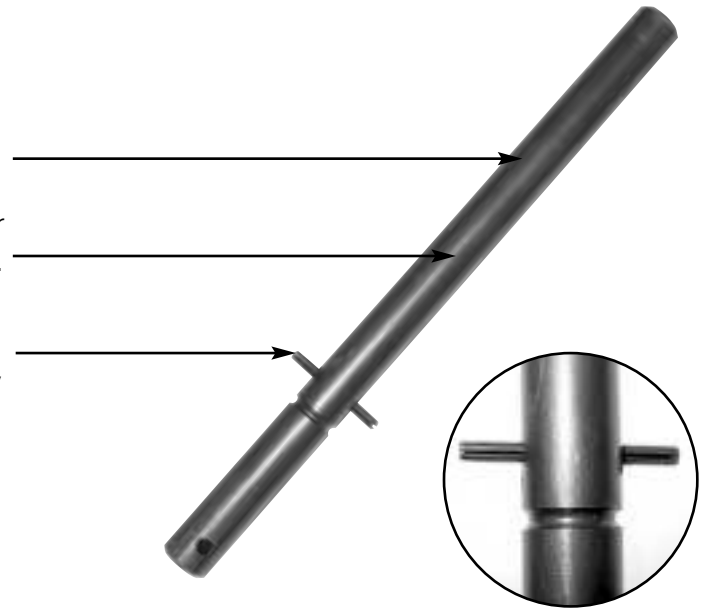

**Part No. B96539C**  
Auger Finger Kit



**Part No. B96538C**  
Deluxe Auger Finger Kit

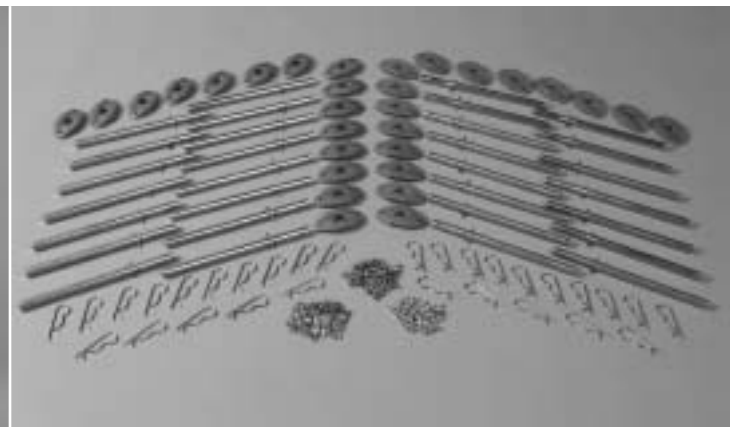

**Part No. B96520**  
Auger Finger Complete Repair Kit

#### KIT SELECTION

PART NO.	DESCRIPTION
B96539C	AUGER FINGER KIT - TWO FINGERS, GUIDES AND HARDWARE
B96538C	DELUXE AUGER FINGER KIT - ONE FINGER, HUB, GUIDE AND HARDWARE
B96520	AUGER FINGER COMPLETE REPAIR KIT

### Knife Drive Assembly

- For 2000 Series headers
- For minimum downtime and new performance - choose the complete replacement

**Part No. 9837960**



### Auger Finger Shaft Bearing Kit

- For 2000 Series headers
- Kit includes bearing, flange, lock collar and mounting hardware
- Handy service pack for shop or tool box

**Part No. B96552C**





# CORN HEAD KITS

## 2200/2400 SERIES CORN HEADS

### NEW STYLE CORN HEAD KNIFE 2200/2400 SERIES CORN HEADS

#### Individual Knife Blades

- Each stalk roll contains two bolt-on knives with two cutting edges
- The blades can be replaced individually without removing the stalk roll from the frame...reducing replacement time
- The cutting edge of the knives are coated with a long wearing tungsten carbide and heat treated making them extremely sharp and durable
- The coating on one side of the knife produces a self-sharpening design that ensures consistent performance throughout the life of the knife

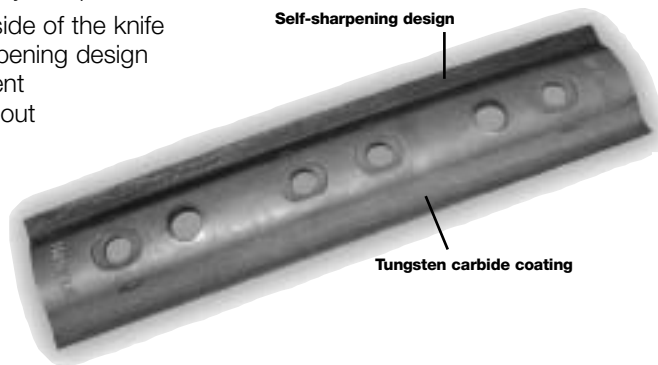

#### Weed Knife - Two Piece Design

- Front weed knife is made of ductile cast iron for improved strength and wear life
- Rear weed knife is made of heat treated formed steel
- Both the front and rear knife kits include knives and hardware to repair one row



Weed Knife Kit - Rear  
Part No. B95581



Weed Knife Kit - Front  
Part No. B95580

### UPTIME PACKS

- Handy Service Packs
- Includes hardware
- Genuine Case IH components



Idler Sprocket Kit  
Part No. B95573



Drive Sprocket Kit  
Part No. B95574A



Ear Saver Kit  
Part No. B95582



Low Profile Point Kits  
Part No. 87017985 - 30' Rows  
Part No. 87017986 - 36', 38' Rows  
Part No. 87017987 - 20', 22' Outer Points

# CORN HEAD KITS

## STALK ROLL REPAIR KITS FOR 2200/2400 SERIES CORN HEADS

- KITS INCLUDE COMPONENTS TO REBUILD ONE ROW
- ALL COMPONENTS ARE ORIGINAL EQUIPMENT QUALITY
- CORN HEAD KNIVES HAVE SUPERIOR TUNGSTEN CARBIDE COATING FOR LONGER WEAR
- CORN HEAD KNIFE HARDWARE IS GRADE 8
- ALL HARDWARE IS INCLUDED



### Corn Head Repair Kit

- Gatherer chains
- Sprockets and hardware
- Packaged

Part No. B96154A

- Kit has chain with standard pins

Part No. B96155A

- Kit has chain with chrome plated pins



Part No. B95583A

### Standard Kit - 1 row Kit includes:

- Corn head knives (4)
- Special hardware

Part No. B95583A



Part No. B95585A

### Deluxe Kit - 1 Row Kit includes:

- Gatherer Chains (2)
- Idler Sprocket (2)
- Drive Sprocket (2)
- Knife (4)
- Special Hardware

Part No. B95585A -

Kit with chrome pins in chains

Part No. B96153A -

Kit with STD pins in chains



Part No. B95584A

### Stalk Roll Assembly - 1 Row Kit includes:

- Stalk Roll tube, knife style (2)
- Knife (4)
- Point RH (1)
- Point LH (1)
- Gatherer Chain (2) with chrome pins
- Idler Sprocket (2)
- Drive Sprocket (2)
- Special Hardware



Part No. 86978515

### Extenda-Wear Chains Kit includes:

- Chrome pins for longer service life
- Wears up to 2.5 times longer than regular duty chains
- Factory equipment on all 2400 Corn heads

Part No. 86978515

### Standard Duty Chains

- Available for 2200/2400 Corn Heads

Part No. 86979313



# CORN HEAD KITS

## EAR SAVER KIT/TALL CORN



### For 2200/2400 Series Corn Heads

- Kit includes components to extend the height of the outer heads/dividers to minimize ear loss in tall corn
- Can be raised to harvest standing corn or lowered to harvest down corn
- Design permits fold-ability of end dividers
- Design minimizes hair pinning
- Heavy duty components for durability and longer service life
- Smooth front to rear transition
- Simple installation complete instruction manual included with each kit

Part No. 87034528

## KITS FOR 2200/2400 SERIES CORN HEADS

### Corn Head Row Unit

- Includes slip clutch
- Painted
- Less stalk roll assembly. Order either the fluted roll style kit or knife roll style kit to complete the corn head unit
- Use existing shields and dividers or poly kits for 2200/2400 Corn heads
- Includes only right hand stripper plate. Order components to equip with manual or hydraulic stripper plates



Part No. B96673A

## LOW PROFILE DIVIDER POINT KITS

- Low profile divider point offers improved performance in down corn conditions by lifting and gathering more down corn stalks than the previous design



6 Row Kit

- Point is designed to keep the tip of the point lower when running 2400 Series Corn heads low to the ground, thereby getting under more corn stalks that lay close to the ground
- The tip of the point is more blunt, which is less likely to spear corn leaves and run cleaner

### PRODUCT SELECTION

PART NO.	DESCRIPTION
87017978	KIT, 6R30", 70CM CAST POINT
87017979	KIT, 6R36", 38" CAST POINT
87017980	KIT, 8R22", CAST POINT
87017981	KIT, 8R30", 70CM CAST POINT
87017982	KIT, 8R36", 38" CAST POINT
87017983	KIT, 12R20", 22" CAST POINT
87017984	KIT, 12R30", CAST POINT
87017985	KIT, 30", 70CM CAST POINT
87017986	KIT, 36", 38" CAST POINT
87017987	KIT, 20", 22" END CAST POINT

Part Numbers 87017985, 87017986, 87017987 include one point and unique mounting hardware. The other kits listed would include points and hardware to complete the corn head listed in the description.

# POLY HOODS, DIVIDER KITS AND COMPLETING KITS

## FOR 2200/2400 SERIES CORN HEADS

- Color-matched high-strength polyethylene shell over heavy duty steel frame
- High-strength polyethylene shell is resistant to cracks, dents and rust for reduced maintenance
- Completely assembled and ready to install
- Includes ear saver
- Replaceable heavy duty cast point to reduce damage to dividers
- For all 2200/2400 series Corn heads—20"-22", 30", 36"-38" and 70 cm

### Divider Assemblies

PART NO.	DESCRIPTION
86620219	INNER 20" - 22"
86620220	INNER 30"
86620221	INNER 36" - 38"
86620222	INNER 70 CM.
86620218	OUTER - ALL ROW SPACINGS

### Hood Assemblies

PART NO.	DESCRIPTION
86620223	INNER 20" - 22"
86620224	INNER 30"
86620225	INNER 36" - 38"
86620226	INNER 70 CM.
86620217	OUTER LH - ALL ROW SPACINGS
86620216	OUTER RH - ALL ROW SPACINGS



Ear Saver Kit  
Part No. B95582



Outer Hood



Inner Hood



Outer Divider

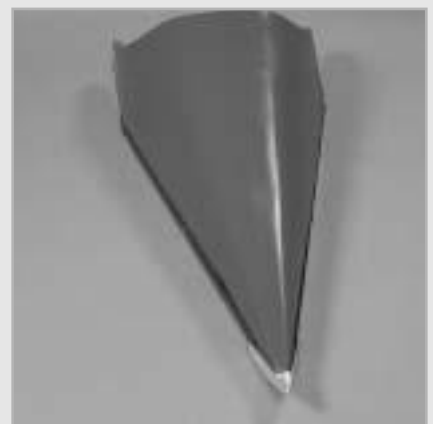

Inner Divider



# COMBINE KITS

## FEEDER KITS

### Feeder Chain Selection

PART NO.	DESCRIPTION	APPLICATION
87283358	Chain w/Serrated Slats	Non-Rock Trap Models
87283359	Chain w/Smooth Slats	Non-Rock Trap Models
87283356	Chain w/Serrated Slats	Rock Trap Models
87283357	Chain w/Smooth Slats	Rock Trap Models
86995344	Connector Link	
86995345	Offset Link	

### Heavy Duty #557 Chain w/ Chrome Pin

- Heavy duty rolled formed slats for maximum strength
- Replaceable bolt-on slats
- Choice of smooth on serrated slats
- Grade 8 Hardware

Part No. 87283358



### Feeder Chain Roller Kit

- Designed to help disengage the feeder chain off the feeder chain sprockets
- Reduces the feeder chain weight on the chain slides
- Greatly reduces feeder housing noise and vibration
- Improves chain life
- For all AFX 8010 combines

Part No. 87298321



### Bearing Kit - Feeder Idler Drum

- Handy service pack
- Kit includes bearings and flanges

Part No. 87297734



### Feeder Chain Slat

Part No. 87297730 - Serrated Slat Kit (shown)

Part No. 87297731 - Smooth Slat Kit

### Crop Deflector Kit

- Direct crop flow for improved and quick transition of crop mat
- Heavy-duty cast
- Kit includes deflectors and mounting hardware

Part No. 87297727



### Bearing Kit - Feeder Drum Drive/Rock Trap Drive

- Handy service pack
- Kit includes: bearing, locking collar, and hardware

Part No. 87297733

# COMBINE KITS

## FEEDER KITS

### Feeder Rock Trap Kit

- Converts a non-rock trap feeder to a rock trap feeder
- Kit includes Beater, Feeder, Chains, Floor, Door, Bearings, Gearbox, Sprockets, Hardware & Instructions
- For all 8010 Models without a factory installed rock-trap



Part No. 87105339



Part No. 84084681

### Perforated Feeder Floor

- Recommended for harvesting edible beans
- Perforated floor will allow small dirt & trash particles to fall through prior to the threshing area

Part No. 84084681



Part No. 84083570

### Feeder Lateral Tilt

- Components to convert a fixed feeder to a feeder with lateral tilt
- Kit is designed to improve harvesting of all varieties over uneven terrain
- Kit includes Feeder Face, Mounting Brackets, hydraulics, Sensor and installation instructions

Part No. 87281928 Model year 2004 & Prior

Part No. 84083570 Model year 2005 +

### Rock Trap Sump Cover Kit

- For rock trap models
- Can be used in non-rocky conditions to improve material flow into transition cone area

Part No. 84083485



Part No. 84083485



# COMBINE KITS

## COMBINE LIGHTING KITS



### HID Light Kit

- HID lamp assembly (2), wire harness (2), ballast(2), hardware and installation instructions
- This kit will add HID lighting to the AFX 8010 combines

Part No. 84084476

### Deluxe Service Lighting Kit

- This kit will help the operator or service personnel when extra lighting is required
- The work lights are positioned to illuminate the concave section of the rotor, belt and pulley areas of the combine
- Two switches control five (5) lamps

Part No. 84083977



### Light Kit

- Handy service light
- Magnetic mount
- 33 Foot cord

Part No. 84059809



### Three Beacon Light Kit

- This kit will add two rotating beacons at the top of the cab and one to the rear of the AFX combine
- Kit includes beacon lights, brackets, and mounting hardware

Part No. 84084474



# COMBINE KITS

## AFX ROTORS

### INCREASED CAPACITY AFX ROTOR

It all starts up front with a 1/2" thick, AR235 steel, constant pitch impeller design, hardened in critical areas. The impellers provide increased throughput capacity, even crop flow, reduced noise levels and reduced parasitic horsepower loss.

The rotor skin is helical, wrapped to provide a more uniform roundness. This virtually eliminates the need to shim rasp bars in hard-threshing small grains. This design is also stronger and less susceptible to denting.

The rotor also features a large, cast, heat-treated drive hub. It bolts into the rear of a stronger rotor and eliminates the rubber bushings and coupler used on earlier models.

All this adds up to greater reliability and lower overall cost of ownership for the customer.



Rotor Selection

PART NO.	DESCRIPTION	APPLICATION
87106026B	COMPLETE ROTOR - 64 NON-SPIKED RASP BARS AND 8 SPIKED RASP BARS IN GRATE AREA	GRAIN, CORN, SOYBEANS, EDIBLE BEANS
87001161B	COMPLETE ROTOR - 64 CHROME ALLOY RASP BARS AND 8 CHROME ALLOY SPIKED RASP BARS IN GRATE AREA	GRAIN, CORN, SOYBEANS, EDIBLE BEANS
87001162B	COMPLETE ROTOR - 72 CHROME ALLOY SPIKED RASP BARS	RICE

### Impeller Wear Bar Kit

- Extends the life of the impeller
- Kit includes two wear bars and mounting hardware

Part No. 87297735



### Rotor Impeller Kit

- 1/2" thick, AR235 steel
- Constant pitch impeller design
- Hardened in critical areas for longer service life

Part No. 84084819



### Rasp Bar Bolt Kit

- 10.9 metric high strength flange bolts
- Kit includes 10 bolts
- Handy service pack for shop or combine tool box

Part No. 87297739



# COMBINE KITS

## RASP BAR AND RASP BAR KITS



### Standard Duty Rasp Bar

- Constructed from long-wearing nodular iron, then quenched and tempered to a specified hardness
- Rasps formed to shape for optimum threshing performance
- Specifically designed for your combine

Part No. 1309336C2 - Non-Spike (Shown)

### RASP BAR SERVICE PACK

- Four bar service kits for AFX 8010 rotors
- Weight sorted for improved rotor performance
- Kit includes four rasp bars and four 10.9 metric flange bolts
- Kits for all type specialty rasp bars-standard-duty bars and chrome alloy bars in both spiked and non-spiked configurations
- Specifically designed for your combine
- Performance, strength, wear-resistance and durability packaged for customer convenience



#### FOUR PACK SERVICE KIT

PART NO.	APPLICATION
87298166	STANDARD-DUTY RASP BAR
87298167	CHROME ALLOY BAR
87298168	CHROME ALLOY SPIKED BAR

### Rasp Bar Kits

PART NO.	DESCRIPTION	APPLICATION
87297737	RASP BAR KIT - CHROME ALLOY RASP BARS	ROTOR 87001161B
87297738	RASP BAR KIT - CHROME ALLOY SPIKED RASP BARS	ROTOR 87001162B
87297740	RASP BAR KIT - STANDARD DUTY RASP BARS	ROTOR 87106026B

- All rasp bars are weight sorted to improve rotor performance
- Kit includes 72 rasp bars and high strength 10.9 metric flange bolts



Rasp Bar Kit  
Part No. 87297737 Shown

### EXTENDA-WEAR™ RASP BAR KITS (CAST CHROME ALLOY)

- 18-23% Chrome for wear-resistance
- 10-50% Heavier than competitors rasp bar
- Thicker casting for improved toughness and wear – leading edge is 5/16" thicker plus added thickness in critical areas for improved toughness and wear resistance
- Reinforced ring around bolt hole for bolt head protection and improved bar strength (larger ring permits use of impact socket for installation)
- Face (leading edge) angle changed to enhance material flow and reduce rock damage to edge
- Tapered radius in corners to prevent cracks
- Individual bars (refer to photos for spiked and non-spiked)

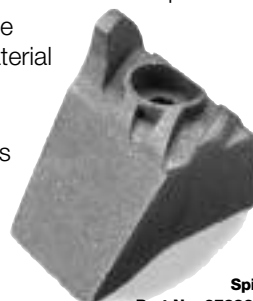

Spiked  
Part No. 278820A4



Non-Spiked  
Part No. 278821A2

# COMBINE KITS

## EXTENDA-WEAR ROTOR CAGE STAINLESS STEEL TRANSPORT VANE KIT



### Extenda-Wear Rotor Cage Kit

- Wear-resistant AR235 steel for longer service life
- Complete with stainless steel vanes and high-strength T-bolts
- Using genuine Case IH rotor cage kits is highly recommended for optimum performance of your combine

Cage Kit - English Hwd - 87297777  
Cage Kit - Metric Hwd - 86980999

- Increased thickness 3/16" – 50% thicker
- Stainless steel material
- The combination of thicker material and more wear-resistance material provides longer service life

Part No. Metric Hardware 84084818  
Part No. English Hardware 87297776

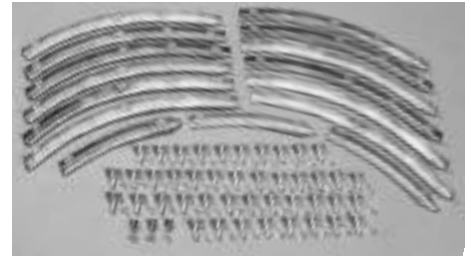

### Stainless Steel Cage Repair Kits

#### T-bolt kit

- 10 bolts and 10 nuts
- Handy uptime pak

Part No. B95908 - 3/8" x 1-1/2"  
Part No. B96425 - 3/8" x 1-1/8"

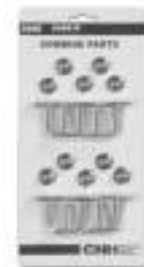

### Front Rotor Module Recommendations

Rotor module recommendations are as follows:

#### Front positions

- Grain, small wire 3/16" heat treated
- Corn/Rice, large wire 1/4"
- Rice, large wire 1/4" heat treated
- Edible beans, slotted

#### Module Rotor Module Options

Rear rotor modules are also a two, two-piece design, nonadjustable, with only two bolts each for removal.

#### Rear positions

- Large skip wire for corn/soybeans/small grain and rice\*
- Slotted for edible beans

Solid rotor modules are available through service parts and are recommended for confectionery sunflowers and other very dry high MOG conditions where it is important to prevent MOG from overloading the cleaning system.

\* Large skip wire rotor modules are the same as large wire front modules (code PC) but 1/2 the wires have been removed. Customers can add or remove wires to better control rotor loss and/or MOG load on cleaning system.

### Module Options

PART NO. LH	PART NO. RH	MODULE DESCRIPTION	POSITION
87282761	87282764	ROTOR MODULE, ROUND BAR	FRONT
86976416	86976414	ROTOR MODULE, LARGE WIRE 1/4" DIA. HEAT TREATED	FRONT
86999090	86999097	ROTOR MODULE, LARGE WIRE 1/4" DIA. HEAT TREATED	FRONT
87000772	87000774	ROTOR MODULE, SLOTTED	FRONT
86976420	86976418	ROTOR MODULE, SMALL WIRE 3/16" DIA. HEAT TREATED	FRONT
87109198	87109201	ROTOR MODULE, LARGE SKIP WIRE	REAR
87106651	87106653	ROTOR MODULE, SOLID	REAR

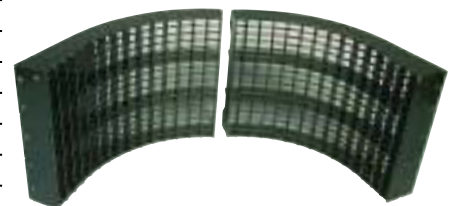



# COMBINE KITS

## CLEANING SYSTEM KITS / GRAIN HANDLING KITS



### Lower Shoe Shaker Arm Bushing Kit

- Handy service pack
- Includes 4 bushings and hardware
- Genuine Case IH components

Part No. 87297749



### Lower Shoe Shaker Arm Deluxe Kit

- Handy service pack
- Includes bushings, housing and hardware
- Genuine Case IH components

Part No. 87297750



### Cross Flow Fan Bearing Kit

- Includes bearings, flanges, and hardware
- Genuine Case IH components

Part No. 87297757 Left hand

Part No. 87297756 Right hand (shown)



### Upper Shaker Shoe Bushing Deluxe Kit

- Handy service pack
- Includes bushings, housing and hardware
- Genuine Case IH components

Part No. 87297759



### Upper Shaker Shoe Bushing Kit

- Handy service pack
- Includes 6 bushings
- Genuine Case IH components

Part No. 87297758



### Clean Grain Bearing Kit - (RH)

- Handy service pack
- Includes bearings, flanges, collar and hardware

Part No. 87297743

### Clean Grain Bearing Kit - (LH)

- Handy service pack
- Includes bearing, flanges, collar and hardware

Part No. 87297742



### Bubble Up Auger Bearing Kit

- Handy service pack
- Includes bearing, flanges, and hardware

Part No. 87297746



# COMBINE KITS

## ROTARY AIR SCREEN KITS

### Front Section

- New screen design for improved performance
- Durable construction
- Includes screen and clips

Part No. 87301194 (fine mesh)  
Part No. 87301195 (coarse mesh)

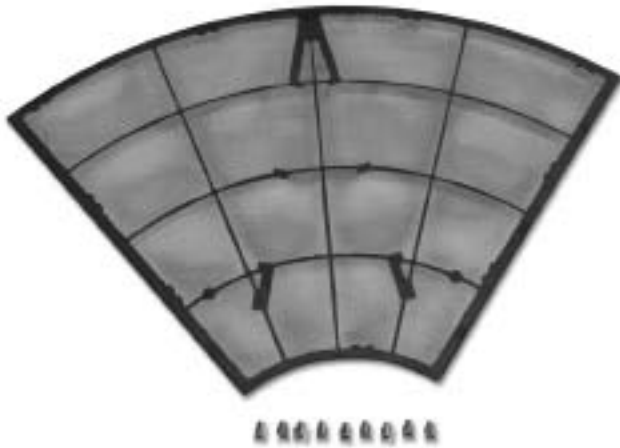

### ROTARY AIR SCREEN WEAR STRIP KIT

- Wear strip kit includes wear strip, hardware, and instructions to replace the wear strip on the plastic rotary air screen
- Inspection of the wear strip is strongly recommended after the first 200 hours of engine operation and then at approximately 50 hour intervals
- Replace this wear strip if any black from the rotary air screen is visible
- Regular inspection of this wear strip and replacement as required can prevent excessive damage to the entire rotary air screen

Part No. 87302735



### Side Section

- New screen design for improved performance
- Durable construction
- Includes screen and clips

Part No. 86988943 (fine mesh)  
Part No. 86988941 (coarse mesh)

### Rotary Air Screen Brush Kit

- Rotary air screen brush kit
- Includes brushes and hardware

Part No. 87297724

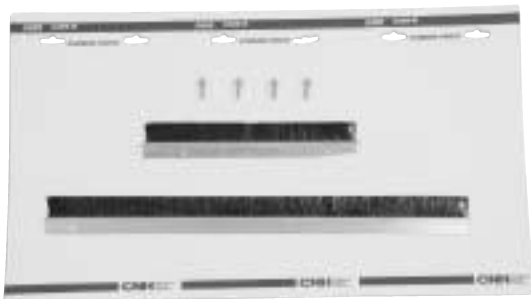

### Screen Clip Kit

- Ten clips in card pack
- Used to install front and side screens

Part No. 87297723





# COMBINE KITS

## GRAIN HANDLING KITS/CLEANING SYSTEM

### Grain Handling Kits

Perforated tailings & clean grain auger throughs & elevator door with round holes

- Kit includes auger throughs and elevator door

Part No. 84084680



Part No. 84084680

### Clean Grain Elevator and Grain Tank Cross Auger Slow Down Kit

- Kit includes sprockets, pulley, sheave
- Kit is designed to reduce the speed of the front grain tank cross auger and the clean grain elevator

Part No. 84084386



Part No. 84084386

### Unloading Auger Extension, 3'

- For use w/18' unloading auger only
- Kit includes 3' tube and auger, bearing, hub and mounting components and hardware

Part No. 86521287



Part No. 86521287

### Cleaning Fan Bottom Shield Kit

- Designed to prevent crop residue from entering the fan area, damaging the fan, and plugging the fan ductwork
- Kit includes the shields and mounting hardware
- Highly recommended for combines harvesting corn and milo crops

Part No. 84083562 (2003/2004 models)  
Part No. 84083564 (for model year 2005)

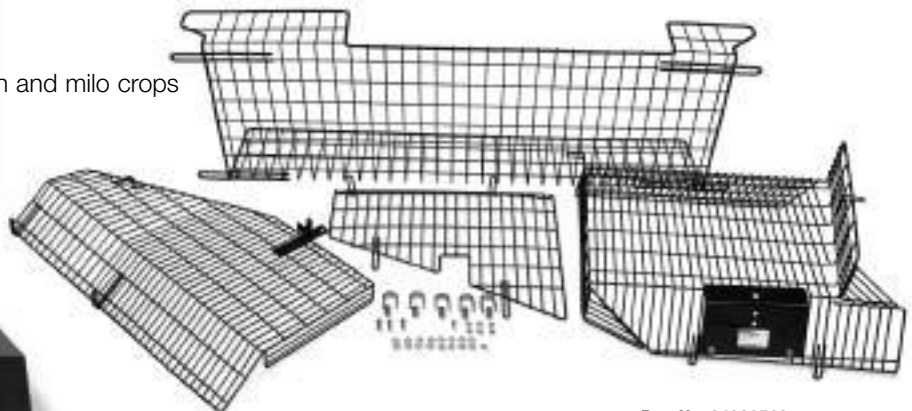

Part No. 84083562



Part No. 84083564

# COMBINE KITS

## GRAIN HANDLING KITS/CLEANING SYSTEM

### Deluxe Hard-to-Thresh Kit

- Designed to process hard to thresh grain that is not threshed in the rotor area
- The cross auger trough has expanded metal applied and the processor door has a rough surface to aggressively process the remaining hard to thresh heads
- Kit includes auger trough with expanded metal surface and processor door with a rough surface

Part No. 84083561



Part No. 84083561

### Hard-To-Thresh Cross Auger Trough Kit

- Designed to process hard to thresh grain
- The cross auger trough has expanded metal applied to aggressively process the remaining hard to thresh heads

Part No. 87283418



Part No. 87283418

### Combine Sieve Selection

PART NO.	DESCRIPTION
84084507	SIEVE, CHAFFER ROUND HOLE 2.5MM - 62"
84084511	SIEVE, CHAFFER ROUND HOLE 10MM - 62"
9560147	SIEVE, CHAFFER ROUND HOLE 16MM - 62"
9560148	SIEVE, CHAFFER ROUND HOLE 18MM - 62"
742135	SIEVE, ROUND HOLE FRAME - 62"
87109826	SIEVE, PRE-CLEANER, 1-5/8" CLOSZ SLAT ADJUSTABLE - 62"
87109821	SIEVE, PRE-CLEANER, 1-5/8" CORN SLAT ADJUSTABLE - 62"
87109817	SIEVE, PRE-CLEANER, 1-1/8" ADJUSTABLE - 62"
84084984	SIEVE, 1-1/8" UPPER - 62"
84084664	SIEVE, 1-5/8" CORN SLAT UPPER - 62"
84084324	SIEVE, 1-5/8" CLOSZ SLAT UPPER - 62"
84084981	SIEVE, 1-1/8" PETERSON UPPER - 62"
84084328	SIEVE, 1-5/8" LOWER - 62"
84084326	SIEVE, 1-1/8" LOWER - 62"
84084662	SIEVE WITH FINGER KIT

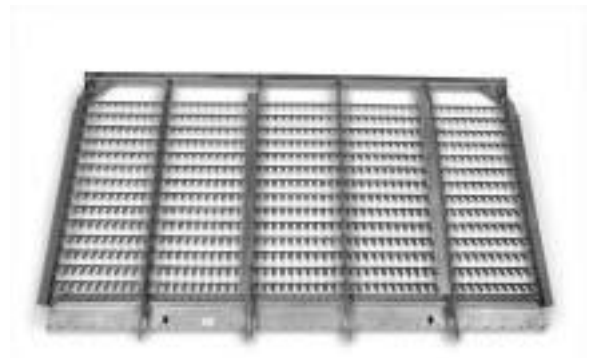

Pre-cleaner sieve

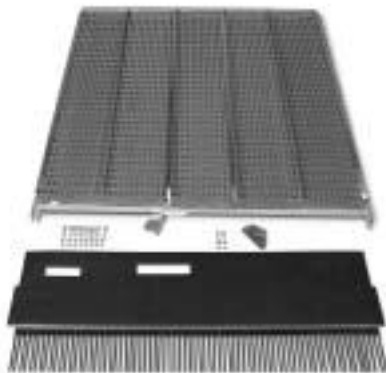

Sieve with finger kit

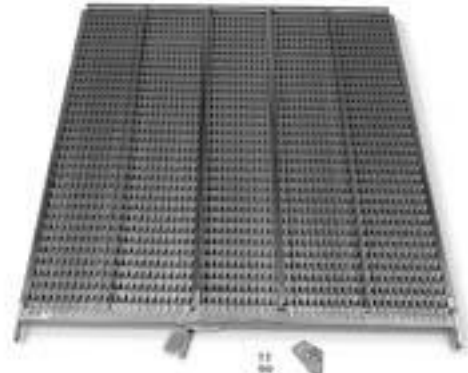

Upper sieve



# COMBINE KITS

## RESIDUE MANAGEMENT KITS



### Rotating Straw Chopper Knife Kit

- For 4 mounts with fine cut configuration
- For 8 mounts with coarse cut configuration
- Includes 8 knives and hardware

Part No. 87297764



### Fixed Straw Chopper Knife Kit

- Complete set

Part No. 87297767 - Coarse cut  
Part No. 87297768 - Fine cut (shown)

### Rotating Straw Chopper Knife Kit

- For fine cut place on opposing mounts
- Includes knives (4) and hardware

Part No. 87297766

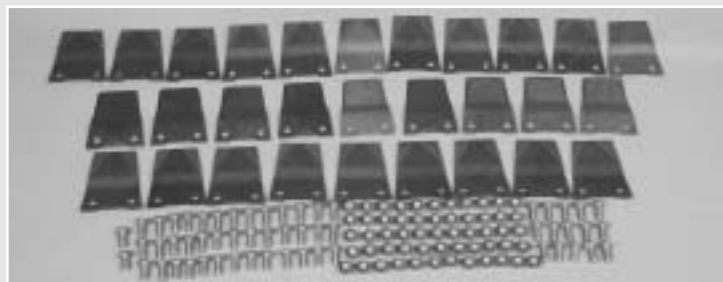

### Rotating Straw Chopper Knife Kit

- Complete set
- Hard surfaced for longer wear life

Part No. 87297762 - Fine Cut  
Part No. 87297877 - Coarse Cut (shown)

### Rotating Straw Chopper Knife Kit

- For coarse cut - place on opposing mounts
- Includes 2 knives and hardware

Part No. 87297765



### Fixed Chopper Knife Assembly

- Includes Bar & Twenty-one (21) Knives (coarse), and Forty-two (42) Knives (fine)
- Easy to assemble

Part No. 87109353 (Coarse Cut) (shown)  
Part No. 87298180 (Fine Cut)

# ACCESSORIES / TOYS



## Chain Breaker

- 1132041R1E For 35-50 roller chain
- 1132042R1E For 60-80 roller chain
- 87298058 (9624833DS) For 100-120 roller chain

Part No. 1132041R1E (shown)



## Ladder Extension Kit

- Includes step, mounting pads and hardware
- Easier entry to combine

Part No. 87297726



## Battery Power Grease Gun

- B95785S - One battery model
- B95786S - Two battery model

Part No. B95785S (shown)



## Fire Extinguisher Kit

- Includes fire extinguisher, decal, and mounting bracket
- Fire extinguisher – 10 lb. capacity, UL rated 4A-60 B:C
- Fire extinguisher – 20 lb. capacity, UL rated

Part No. 84084936 - 10 lb. capacity  
Part No. B95915 - 20 lb. capacity



## AFX 8010 Combine Toy

- 1/32 scale model

Part No. ZFN14290

## AFX 8010 Combine Toy

- 1/64 scale model

Part No. ZFN14279



## MOISTURE TESTERS - GRAIN



Part No. B96650

### MT-16 GRAIN MOISTURE TESTER

(SUPERSEDES MODEL MT3)

#### Features

- Direct readout for 16 grains: Barley, Canola, Corn, Flax, Oats, Rice (2), Sorghum, Soybeans, Sunflower (2) & Wheat (4)
- Each scale can be adjusted to match local elevator
- Automatically averages up to 99 test results
- Repeatability in normal range of stored grain within 0.5% of air-oven standard. Higher-frequency, capacitive circuit improves accuracy
- Includes sturdy carrying case with strap
- 2 year warranty in North America, 1 year overseas



Part No. B96649

### MT-PRO™ MULTI-GRAIN, MULTI-LANGUAGE, GRAIN MOISTURE TESTER

#### Features

- 39 grain scales
- Information displays in 7 languages: English, French, German, Spanish, Portuguese, Italian, & Swedish
- Multi-Point™ adjustable calibration
- Averaging capability displays running average of tests
- Back lighted display
- Higher-frequency, capacitive circuit improves accuracy
- Enhanced temperature compensation circuit
- Optional carrying case - Part No. 87297026

#### Specifications

- Operating Range (Moisture): 5% to 40% depending on grain tested
- Operating Range (Temperature): 32°–113° F (0°–45° C)
- Repeatability: +/- 0.5% in normal moisture range for stored grain
- Accuracy: +/- 0.5% in normal moisture range for stored grain
- Display Resolution: 0.1% moisture
- 2 year warranty in North America and 1 year overseas



Part No. B95379

### MOISTUREMATCH™ Grain Tester

#### Features

- Large Graphic LCD shows multiple readouts and on-line instructions. Backlit for night use.
- Averaging Capability displays the last six test results and running average of tests. Individual results can be deleted.
- 33 Grain scales
- MOISTUREMatch Technology – user selects from one of five options: Motomco 919, Motomco 919E, DICKEY-john GAC 2000, Labtronic (Canada), Industry Standard.
- Compaction Sensor Technology displays moisture automatically when optimum grain compaction threshold is reached.
- Graphic Calibration Adjustment™ allows user to fine-tune calibration to “match” a specific commercial tester. Calibration adjustments shown on graphic display.
- Optimal Test Cell Geometry for more accurate and repetitive results.

- Larger Test Cell for more representative sample.
- EZ-Fill Grain Scoop makes filling test cell quick and clean. Stores inside test cell between uses.
- Molded Hand Grip for safe & comfortable operation.
- Computer Interface for updating moisture scales and software upgrades. RS 232 serial port uses standard computer serial cable (not included).
- Optional Carrying Case - Part No. B95380.



#### Specifications

- Operating Range (Moisture): 5% to 40% depending on grain tested.
- Operating Range (Temperature): 32°–113° F (0°–45° C).
- Repeatability: +/- 0.5% in normal moisture range for stored grain.
- Accuracy: +/- 0.5% in normal moisture range for stored grain.
- Display Resolution: 0.1% moisture.
- 2 year warranty in North America, 1 year overseas.

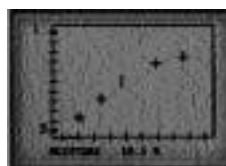
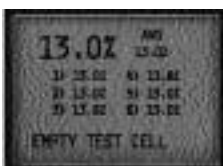

# LUBRICANTS AND FILTERS

## **AFX 8010 COMBINES**

### Filters

ENGINE OIL	FUEL	HYDRAULIC	AIR	CAB
84818743	84818745 & 84989840 (TANK)	254353A1 277311A1 (IN-LINE) 294721A1 (RETURN)	86998333 (O) 86998332 (I)	84058793 & 84036676

### Lubricants

ENGINE OIL	NO. 1 MULTI GRADE W/2 FILTERS 8.5-GAL 32L
HYDRAULICS	HY-TRAN ULTRA 15-GAL 57L
HYDROSTATIC	PTO GEARBOX/HYDROSTATIC SYSTEM HY-TRAN ULTRA RESERVOIR 14.5-GAL 55L REFILL INCL. FILTER 6.3-GAL 24L
TRANSMISSION	135HEP 80W-90 TRACTION GEARBOX 5-GAL 19L
FINAL DRIVE EACH	135HEP 80W-90 7.1-QT 6.7L
POWER REAR AXLE	—
GEAR BOXES EACH	135HEP 80W90 UNLOADING DRIVE .64-QT .6L UNLOADING TUBE .45-QT .43L HY-TRAN ULTRA TAILINGS .26-QT .25L BUBBLE UP .53-QT .5L ROTOR 7.4-QT 7L FEEDER CONV. 3-QT 2.8L HEADER 2.5-QT 2.4L



# ACCESSORY KITS

## ADVANCED FARMING SYSTEM

Case IH is pleased to announce the next step in precision farming – a Universal Display that easily moves from use as a yield monitor, to a planter monitor or a seed monitor, with complete variable rate application control! You don't even have to reconfigure the unit when you move from machine to machine. Just disconnect from your tractor cab and your AFS Planter or Concord® Air Seeder, and connect to your **Axial-Flow®** combine as a yield monitor. The display automatically knows the function that it is to perform.

Now, Case IH offers parts kits to allow you to upgrade your AFX 8010 Series **Axial-Flow** combine to the latest technology, no matter what your current configuration. Whether you have a combine that currently has no yield monitor, a combine with a yield monitor only, or a full AFS combine, we have the kits to meet your specific needs.

For more details on features, kits required for upgrades, please refer to PM-11765 (Case IH Advanced Farming Systems) or the AFS Sales Support Manual.

### AFS UNIVERSAL RECEIVER KIT

The AFS Universal Receiver is the first 12-channel GPS receiver with sub-meter accuracy, featuring a combination of Coast Guard beacon differential correction, WAAS and satellite differential correction. It uses L-band technology, the future of satellite-based positioning systems. The Universal Receiver has a two-line LCD display with keypad that allows for easy configuration and diagnostics. The Universal Receiver does require a subscription code in order to use the satellite differential correction, but this subscription code can be loaded via the satellite signal. The Coast Guard beacon, and WAAS differential signals are free and do not require a subscription.

The antenna and receiver combined weigh less than two pounds, which makes for easy portability between combine, tractor, pick-up or sprayer. The antenna has a magnetic mount for removal and installation.

Kit includes receiver and antenna. Mounting kit must be ordered separately.

### CASE IH "XTRA-VISION" VEHICLE OBSERVATION SYSTEM

With the new Case IH "XTRA-VISION" Vehicle Observation System, equipment operators can now watch critical views of machine or implement operation they could never see before!

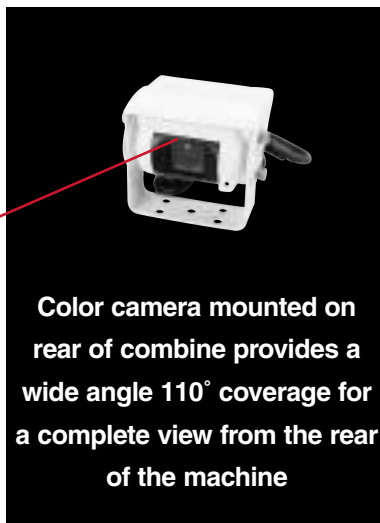

**Color camera mounted on rear of combine provides a wide angle 110° coverage for a complete view from the rear of the machine**

**AFS**



Part No. 293593A7



Moisture By-Pass Sensor



Part No.	Description
ZAE1CS	COMPLETE SYSTEM KIT
ZAE100AOC	COLOR CAMERA
ZAE2CAM	DUAL CAMERA ACCESSORY
ZAE641LCM	COLOR MONITOR
ZAE45SEMI	IMPLEMENT/TRAILER CABLE KIT
ZAE65EXT	EXTENSION CABLE

# PRODUCTIVITY TIPS/GUIDES

## SELF DIRECTED LEARNING PROGRAM



### Theory of Combine Settings and Adjustments of the Axial-Flow Combine

**USMHAF2C3EN** — This highly interactive training program focuses on the theory of crop flow as it relates to various machine settings & adjustments. This tool is designed to give the first time owner, or the seasoned veteran, a closer look at various machine settings and adjustments that can maximize grain quality, as well as overall grain saving abilities. With interactive media such as animations, video clips, and drop down menus, this is a comprehensive course that allows you to sharpen up on the proper sequence of adjustments for achieving related outcomes. This course is designed to take 40 to 50 minutes. Price US\$45/CDN\$60.

**USMHAF2C4EN** — Theory of Combine Settings & Adjustments Post Assessment.

Available from Document Management Center.

## USER GUIDE FOR COMBINE SEPARATOR ADJUSTMENT SLIDE RULE



PM-13000

### Separator adjustments are key to combine productivity

The slide rule provides a convenient portable tool to help the customer adjust his/her combine to do the best job possible. It covers most of the common crops and utilizes the information in the combine productivity flyer.

It fits in the buddy seat compartment so it is available when needed. It is easy to read, easy to follow and gives step-by-step instructions to improve combine performance.

They help even experienced customers by providing a refresher to what can be adjusted and in what order to do the adjustments. They help new owners to adjust by giving them an easy to follow procedure that allows them to adjust Axial-Flow combines like a seasoned pro.

#### How to use:

Identify the symptom you have, line up the slide rule with the symptom, and read the adjustments in order of priority.

#### Why:

To gain maximum productivity from your machine.

#### When:

Whenever a new rotary user operates the machine. A great starting tool to make changes to setting the machine, or when an experienced owner is using the machine and harvest conditions change, the crop being harvested is different, and/or setting the machine for maximum productivity.

# PERFORMANCE KITS

## Axle and Operator Deck Extensions - See Combine Ordering Guide for Requirements

Part No.	Description
84060286	AXLE EXTENSIONS - 100MM SPACER
84095969	AXLE EXTENSIONS 138MM (5.4)
84095964	AXLE EXTENSIONS 265MM (10.4)*
84095959	AXLE EXTENSIONS 316MM (12.4)

Part No.	Description
84083290	OPERATOR DECK EXTENSION - 250MM (10')
84083291	OPERATOR DECK EXTENSION - 500MM (20')
84083292	OPERATOR DECK EXTENSION - 750MM (30')

## Feeder Kits

Part No.	Description
87105339	FEEDER ROCK TRAP INSTALLATION CONVERSION KIT - CONVERTS A NON-ROCK TRAP FEEDER TO A ROCK TRAP
87105340	FEEDER ROCK TRAP REMOVAL CONVERSION KIT - CONVERTS A ROCK TRAP FEEDER TO A NON-ROCK TRAP
87281928	FEEDER LATERAL TILT KIT FOR 2004 MY AND PRIOR
84083570	FEEDER LATERAL TILT KIT FOR 2005+ MY
84084681	PERFORATED FEEDER FLOOR
84084684	FEEDER TOP SHAFT SPROCKET STRIPPER PACKAGE OIL
84083484	FEEDER FACE STRIPPER KIT - REQUIRED IF USING 2003 MODEL HEADERS (EXCEPT DRAPER) ON 2004+ MODEL AFX COMBINES
84083485	ROCK TRAP SUMP COVER KIT

## Grain Handling Kits

Part No.	Description
84084680	PERFORATED TAILINGS & CLEAN GRAIN AUGER TROUGHS AND ELEVATOR DOOR - ROUND HOLES
84084386	CLEAN GRAIN ELEVATOR AND GRAIN TANK CROSS AUGER SLOW DOWN KIT*
86521287	UNLOADING AUGER EXTENSION, 3' (FOR USE W/18' UNLOAD AUGER ONLY)

## Residue Handling Kits

Part No.	Description
84083460	DISCHARGE BEATER GRATE COVER KIT - RECOMMENDED TO REDUCE MOG ON THE CLEANING SYSTEM IN DRY BRITTLE CONDITIONS, AND TO PREVENT SIEVE LOUVER DAMAGE IN CORN

## Lighting Kits

Part No.	Description
84084474	BEACON LIGHTS
84084476	HID STADIUM LIGHTS
84083977	SERVICE LIGHTS, DELUXE UNDER TRIM PANEL
84081054	SERVICE LIGHT, HAND HELD PORTABLE

## Precision Farming Kits

Part No.	Description
84083168	YIELD AND MOISTURE SENSOR KIT
87282475	GPS RECEIVER INSTALLATION KIT - REQUIRED TO INSTALL ANY GPS RECEIVER ORDERED AS A DIA
84083169	AFS110 RECEIVER - RECEIVES WAAS AND L-BAND DGPS SIGNALS; REQUIRES 87282475 INSTALLATION KIT
84083170	AFS100 RECEIVER - RECEIVES WAAS DGPS SIGNAL ONLY; REQUIRES 87282475 INSTALLATION KIT
84083373	UNIVERSAL RECEIVER TRANSFER KIT - INCLUDES ALL WIRING AND MOUNTING HARDWARE TO INSTALL AN AFS132 UNIVERSAL RECEIVER IN AFX COMBINE

## Other

Part No.	Description
84083386	FIXED NA TRAILER HITCH DIA
84083387	AUT TOR NA HDR HITCH DIA
84084936	FIRE EXTINGUISHER - NA
84081496	ENGINE COOLANT HEATER - IVECO 10.3L
84110799	2-SPEED POWERED REAR AXLE KIT - CONVERTS A PRA FROM SINGLE SPEED TO 2-SPEED. (FOR MY 2004 & PRIOR, REQUIRES SWITCH PAD #87282484 ORDERED SEPARATELY)

# INDEX

Part No.	Page	Part No.	Page	Part No.	Page
742135	25	84084664	25	86976420	21
801462*	9	84084680*	24	86977981	7
9560147	25	84084680*	32	86977982	7
9560148	25	84084681*	17	86978515	13
9826150	6	84084681*	32	86979313	13
9837960	11	84084684	32	86980999*	21
84036676	29	84084818*	21	86988941*	23
84058793	29	84084819*	19	86988943*	23
84060286	32	84084936	27	86995344	16
84059809*	18	84084936	32	86995345	16
84081054	32	84084981	25	86998332	29
84081496	32	84084984	25	86998333	29
84083168	32	84095959	32	86999090	21
84083169	32	84095964	32	87000772	21
84083170	32	84095969	32	87015706	6
84083290	32	84110799	32	87015708	6
84083291	32	84818743	29	87016131*	9
84083292	32	84818745	29	87016132*	9
84083373	32	84989840	29	87016167*	10
84083386	32	86521287*	24	87017978	14
84083387	32	86521287*	32	87017979	14
84083418	25	86608231	10	87017980	14
84083460	32	86616527	7	87017981	14
84083484	32	86616528	7	87017982	14
84083485*	17	86616529	7	87017983	14
84083485*	32	86616689	7	87017984	14
84083561	25	86616692	7	87017985	12
84083562	24	86616693	7	87017985	14
84083564	24	86620216	15	87017986	12
84083570*	17	86620217	15	87017986	14
84083570*	32	86620218	15	87017987	12
84083977*	18	86620219	15	87017987	14
84083977*	32	86620220	15	87034528	14
84084324	25	86620221	15	87045432	6
84084326	25	86620222	15	87105339	17
84084328	25	86620223	15	87105339	32
84084386*	24	86620224	15	87105340	32
84084386*	32	86620225	15	87106651	21
84084474*	18	86620226	15	87109198	21
84084474*	32	86705199*	8	87109817	25
84084476*	18	86900832	7	87109821	25
84084476*	32	86900833	7	87109826	25
84084507	25	86900834	7	87281928*	17
84084511	25	86900835	7	87281928*	32
84084662	25	86976416	21	87282475	32

# INDEX (CONTINUED)

Part No.	Page	Part No.	Page	Part No.	Page
87282761	21	87297974	8	B95409	10
87283356	16	87297975	8	B95573	12
87283357	16	87297976	8	B95574A	12
87283358	16	87297977	8	B95580	12
87283359	16	87297978	8	B95581	12
87297026	28	87297979	8	B95582	12
87297723	23	87297980	8	B95582	15
87297724	23	87297981	8	B95583A	13
87297726	27	87297982	8	B95584A	13
87297727	16	87297983	8	B95585A	13
87297730	16	87298058	27	B95623	8
87297731	16	87298163	9	B95624	8
87297733	16	87298163	10	B95644	8
87297734	16	87298164	9	B95645	8
87297735	19	87298164	10	B95785S	27
87297737	20	87298166	20	B95856	10
87297738	20	87298167	20	B95857	10
87297739	19	87298168	20	B95872	10
87297740	20	87298180	26	B95908	21
87297742	22	87298212	8	B95915	27
87297743	22	87298213	8	B96153A	13
87297746	22	87298321	16	B96154A	13
87297749	22	87301194*	23	B96155A	13
87297750	22	87301195*	23	B96425	21
87297756	22	87302735*	23	B96520	11
87297757	22	87442324	6	B96538C	11
87297758	22	87442329	6	B96539C	11
87297759	22	1132041R1E	27	B96552C	11
87297762	26	1132042R1E	27	B96649	28
87297764	26	1309336C2	20	B96650	28
87297765	26	254353A1	29	B96673A	14
87297766	26	277311A1	29	PM-13000	31
87297767	26	278820A4	20	USMHAF2C3EN	31
87297768	26	278821A2	20	USMHAF2C4EN	31
87297776	21	293593A7	30	ZAE100AOC	30
87297777	21	294721A1	29	ZAE1CS	30
87297877	26	87001161B	19	ZAE2CAM	30
87297938	7	87001162B	19	ZAE45SEMI	30
87297943	7	87106026B	19	ZAE641LCM	30
87297944	10	87109353E*	26	ZAE65EXT	30
87297945	10	87297170C	8	ZFN14279	27
87297946	10	B95379	28	ZFN14290	27
87297972	8	B95380	28		
87297973	8	B95408	10		

\*Depot only



Case IH dealers are the standard for expert sales, service and support of the most technologically advanced equipment in the world. They're committed to understanding your business and providing unique solutions to maximize your productivity.

From tractors to implements that meet the specific needs of your operation, Case IH dealers offer a complete agricultural system aimed at increasing your productivity and profitability. Coupled with timely parts and service, and flexible financial solutions through CNH Capital, Case IH dealers provide a total package to ensure you're always performing at your best.

But most importantly, Case IH dealers offer planning for the long-term growth of your business. By staying at the forefront of agronomic issues and the cutting edge of technology, they help prepare you for tomorrow.

Whatever it takes, Case IH dealers are dedicated to helping your operation achieve success season after season. Visit your Case IH dealer today to see the advantages of worldwide leadership.

Financing provided by

**CNH Capital**



**SEE YOUR LOCAL CASE IH DEALER**

 **SAFETY NEVER HURTS!**<sup>TM</sup> Always read the Operator's Manual before operating any equipment. Inspect equipment before using it, and be sure it is operating properly. Follow the product safety signs, and use any safety features provided.

Case IH is a registered trademark of CNH America LLC

CNH Capital is a trademark of CNH America LLC

Any trademarks referred to herein, in association with goods and/or services of companies other than CNH America LLC, are the property of those respective companies.

CNH America LLC reserves the right to make improvements in design and changes in specifications at any time without notice and without incurring any obligation to install them on units previously sold. Specifications, descriptions and illustrative material herein are as accurate as known at time of publication, but are subject to change without notice.

This literature has been published for worldwide circulation. Availability of some models and equipment builds varies according to the country in which the equipment is used.

 **CNH ORIGINAL PARTS ENGINEERED FOR CASE IH EQUIPMENT.**  
SUPERIOR QUALITY, GLOBAL SUPPORT.

**CASE IH**